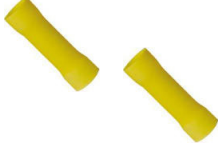
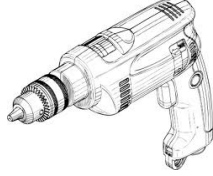

## PARTS NEEDED:

	
<p>Drink Holders</p>	<p>Butt Splice Connectors (Not Provided)</p>

## TOOLS NEEDED:

	
<p>Power Drill</p>	<p>Hole Saw Bit</p>

1. Determine the installation location and drill a 3-5/8" hole using a hole saw (Note: For part #81427SS304 you will need to drill a 4" hole).

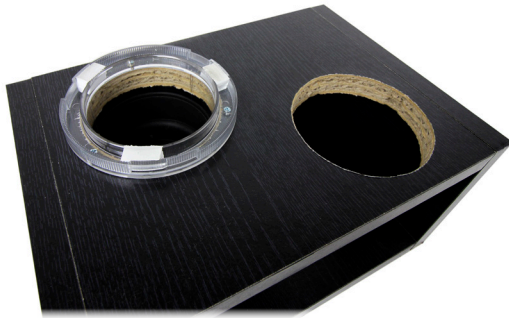

2. If installing a standard drink holder proceed to step 3. If installing a lit drink holder follow the wiring instructions below.

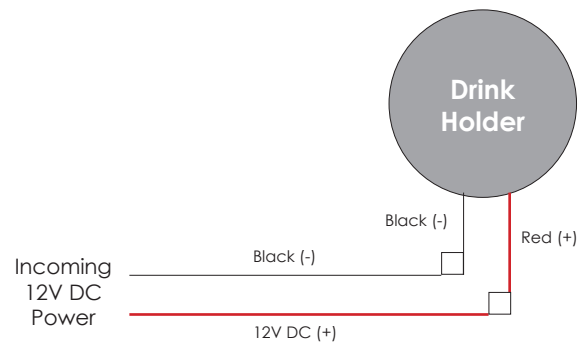

Single Color Option

3. If installing an adhesive mount drink holder, simply remove the paper backing and press in place. If installing the screw mount cup holder screw down using the provided screws and replace the decorative ring.

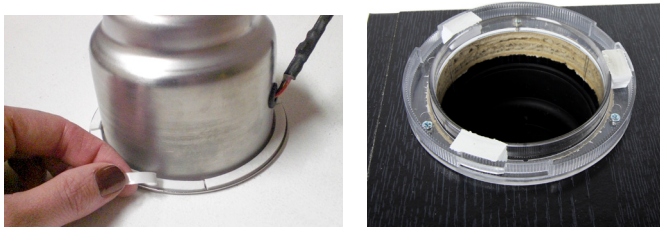

Adhesive Mount

Screw Mount

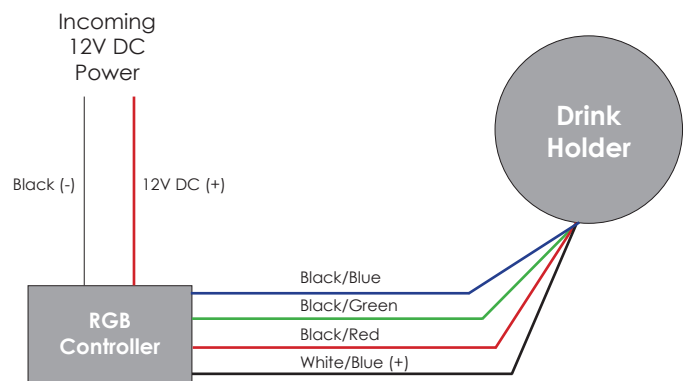

VersiColor RGB Option

For warranty information please visit [www.itc-us.com](http://www.itc-us.com)

3030 Corporate Grove Dr. • Hudsonville • MI • 49426

Phone: 616-396-1355 • Fax: 616-396-1152 • [www.itc-us.com](http://www.itc-us.com) • [sales@itc-us.com](mailto:sales@itc-us.com) • 08/10/17