





Underwater Light Install Instructions

(Part #'s: 69683SS-XX)

PARTS / TOOLS NEEDED:

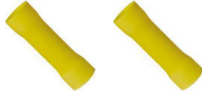
			
Underwater Light	RGB Controller (RGB version only)	Power Drill w/ Hole Saw Bit	Butt Splices (not provided)

Safety Instructions

- Disconnect power before installing, adding or changing any component.
- To avoid a hazard to children, account for all parts and destroy all packing materials.
- Do not install any luminaire assembly closer than 6" from any combustible materials.
- Positive (+) outputs require a fuse if the attached wire leads are not rated to handle the max current.

1. Determine the installation location and mark the location using the provided template. You can also mark the hole locations using the light itself.

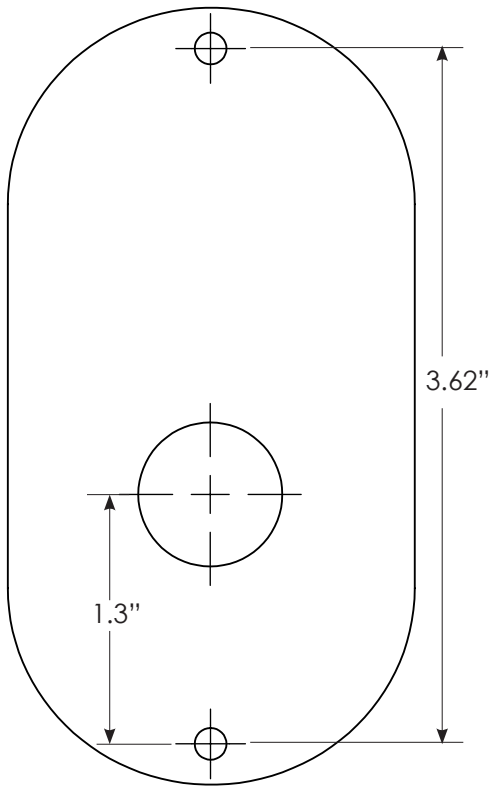

2. Drill a 3/4" hole to accommodate the wiring. Feed wires through the hole.



3. Drill two holes for M4 screws sized appropriately for the substrate material used. Snap on the bezel and screw the light in place using the provided screws.



4. Follow the wiring diagram below to wire the light to your system.

Single Color Light

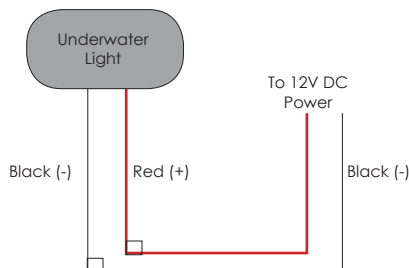

RGB Light

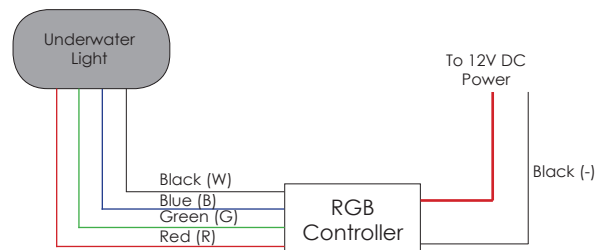

For warranty information please visit www.itc-us.com

3030 Corporate Grove Dr • Hudsonville • MI • 49426

Phone: 616-396-1355 • www.itc-us.com • sales@itc-us.com • DOC#: 710-00031 Rev C • 11/29/18