









Hardtop Light Installation Instructions

(Part #: 69670B-XX-KKKK)

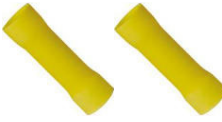
PARTS/TOOLS NEEDED:

					
Hardtop Light	Decorative Bezel	Mounting Screws	2" Hole Saw Bit (not provided)	Butt Splice Connectors (not provided)	Power Drill (not provided)

IMPORTANT SAFETY INSTRUCTIONS. READ CAREFULLY FOR YOUR PROTECTION AND SAVE ALL INSTRUCTIONS.

- *Disconnect power before installing, adding or changing any component.
- *To avoid a hazard to children, account for all parts and destroy all packing materials.

1. Determine the installation location for your light. Once determined drill a 2" hole using a hole saw.

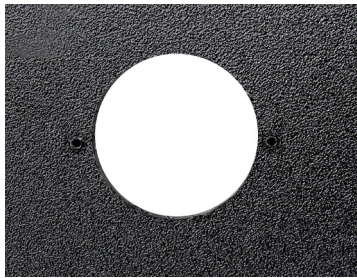

*Optional, predrill screw holes

2A. Feed wires back through the hole and screw the light in place using the screws provided.

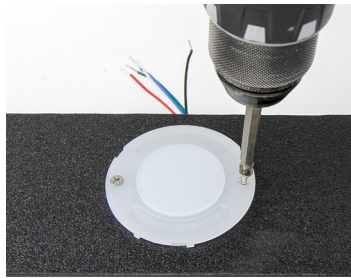

*Follow wiring diagram below before screwing light in place

3. Attach the bezel by lining up the cutouts and rotating until it snaps in place.



Bi or Tri Color Wiring Diagram

2B. Wire the light following the wiring diagrams below. The color sequence of the Tri color light will be as follows: 3000K → Off → 4000K → Off → 6500K OR Red → Off → Blue → Off → 6500K | The color sequence of the Bi color light will be as follows: 3000K → Off → 6500K. If the light is off for more than 30 seconds it will re-start the cycle.

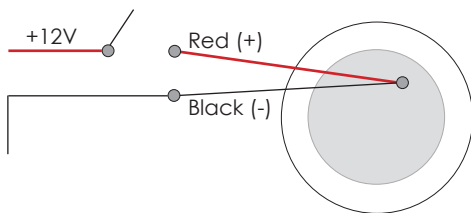

VersiColor RGBW Wiring Diagram

2B. Wire the light following the wiring diagrams below.

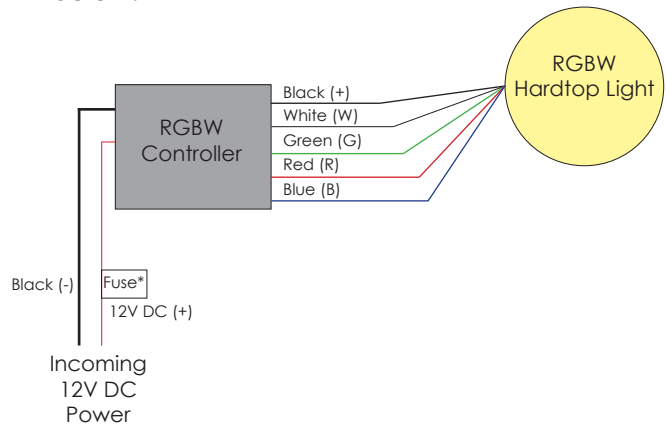

*It is highly recommended that appropriate fusing be used.

For warranty information please visit www.itc-us.com/warranty

3030 Corporate Grove Dr • Hudsonville • MI • 49426

Phone: 616-396-1355 • www.itc-us.com • sales@itc-us.com • DOC #: 710-00091 • Rev B • 11/18/19